

Comparison of Various Optical Amplifiers on Performance of 16-64channels WDM System

Jagneet Kaur
M.E. EE Department
Chandigarh University
Mohali, Punjab, India.
kourjagneet@gmail.com

Inderpreet Kaur
Professor, EE Department
Chandigarh University
Mohali, Punjab, India.
inder_preet74@yahoo.com

Kamal Kant Sharma
Assistant Professor, EE Department
Chandigarh University
Mohali, Punjab, India.
sharmakamal2002@gmail.com

Abstract- In optical networks by means of hybrid optical amplifier WDM system is emerging rapidly. By the use of hybrid optical amplifier, the output of WDM system is increased. In this research article through several optical in different channels, it has been concluded that they are suitable for better performance with lesser number of channels. Their benefits can be recognized after the output of all established networks. Several combinations of hybrid optical amplifiers were used to find the advantage as well as limitations of existing amplifier

Keywords—DWDM, EDFA, Hybrid Amplifiers, FRA.

I. INTRODUCTION

WDM is considered for a single fiber to increase its transmission capacity. WDM is an emerging technology that joins several independent information carrying wavelengths and for the single fiber. In WDM, every optical channel has a wavelength range with its own wavelength. The spacing of typical optical channel may be 1nm wide or less. Optical amplifier is the key component of WDM system. In order to allow various channels in similar optical bandwidth, it is considered to set a very narrow grid of optical carriers in WDM system. By this, optical amplifier has demand with high gain, flat gain and very broad profile to identical amplification factors of each channel in the system. High capacity & long hold transmissions involved by WDM system. As WDM system shown in recent experimental advances, thus hybrid amplifiers are efficient and promising technology for future multi terabit systems of WDM systems of WDM . There is a well established methodology of using amplifiers for utilization of fiber bandwidth available that is through several combinations of various amplifiers in separate wavelength ranges. Hybrid amplifier is the term in with the configuration of amplifiers is connected either in parallel or in series.[1] Regarding parallel configuration, the signals of WDM firstly demultiplexed with the help of a coupler into various wavelength band groups then with the help of amplifier they are amplified and gain wavelength bans and with the help of coupler they are multiplexed again. An EDFA with combination of fiber Raman amplifier for amplification to achieve a higher gain with lower noise .[3-6] closed form analysis of hybrid FRA/EDFA is obtain from Optimal configuration. By comparing system of different configurations, there is nonlinearities impact of fiber has been introduced[7-11]. In this paper, authors proposed comparison of two channels i.e. 16 and 64 with additional comparison of EDFA-FRA, FRA-FRA, FRA-EDFA, EDFA-EDFA to examine quality factor, threshold, max BER and other related parameters.

The transmission of sixteen wavelengths in WDM ranging from 1471 nm to 1611 nm system is shown in Figures1, 2 and3. The transmitter subsystem comprises of input signals and a multiplexer. Then, in the optical transmission link,

several fiber spools are placed before the receiver subsystem which consists of a demultiplexer.

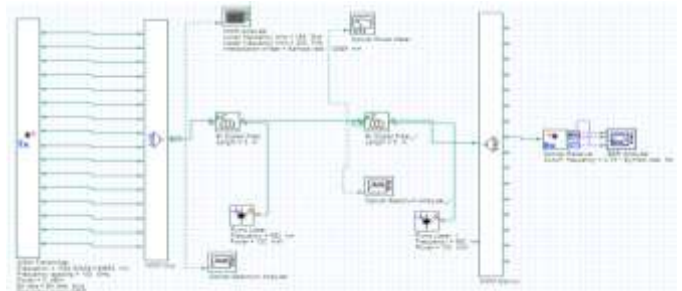

Figure. 1a

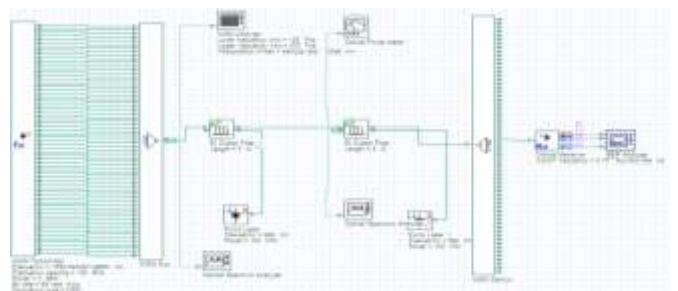

Figure. 1b

Figure 1(a-b). Comparison of transmission between EDFA-EDFA of sixteen and sixty four channels with wavelengths ranging from 1471 nm to 1611 nm. 1a. When EDFA–EDFA are connected in sixteen channel WDM system. 1b. When EDFA –EDFA are connected in sixty four channel WDM system.

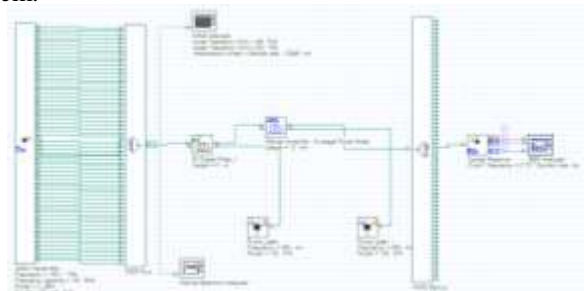

Figure. 2a

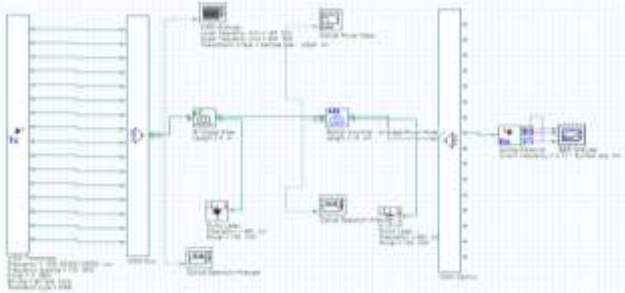

Figure. 2b

Figure 2(a-b). Comparison of transmission between EDFA-FRA of sixteen and sixty four channels with wavelengths ranging from 1471 nm to 1611 nm. 2a. When EDFA –FRA are connected in sixteen channel WDM system. 2b. When EDFA –FRA are connected in sixty four channel WDM system.

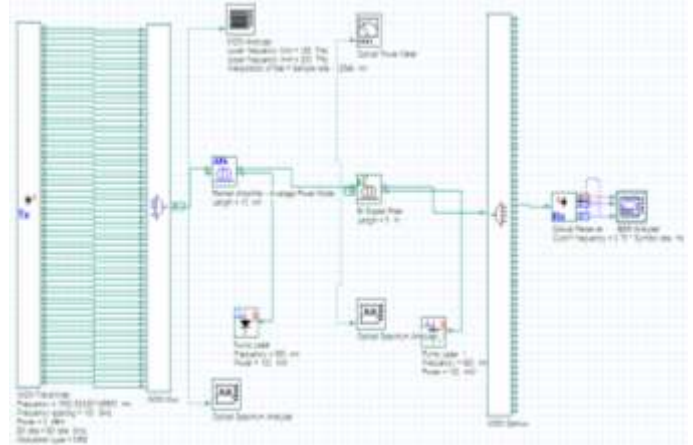

Figure. 4b

Figure 4(a-b). Comparison of transmission between FRA-EDFA of sixteen and sixty four channels with wavelengths ranging from 1471 nm to 1611 nm. 4a. When FRA–EDFA are connected in sixteen channel WDM system. 4b. When FRA –EDFA are connected in sixty four channel WDM system.

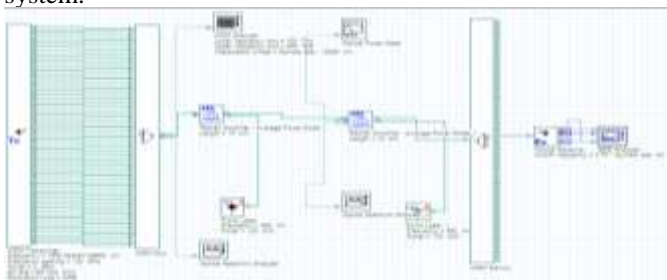

Figure. 3a

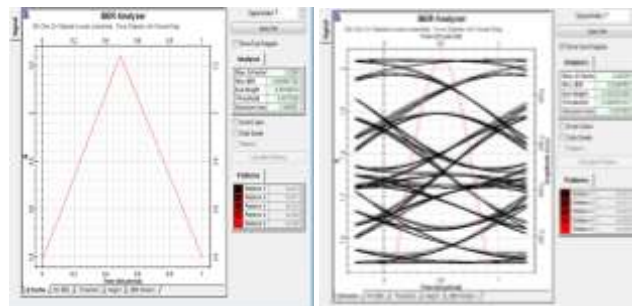

Figure. 5a

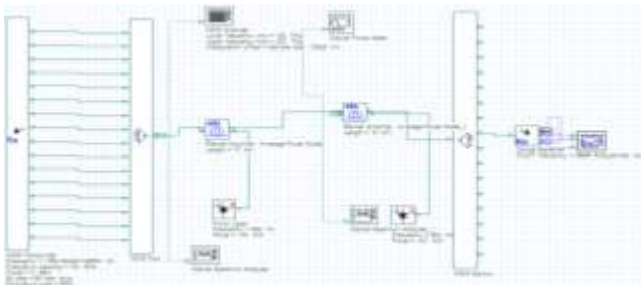

Figure. 3b

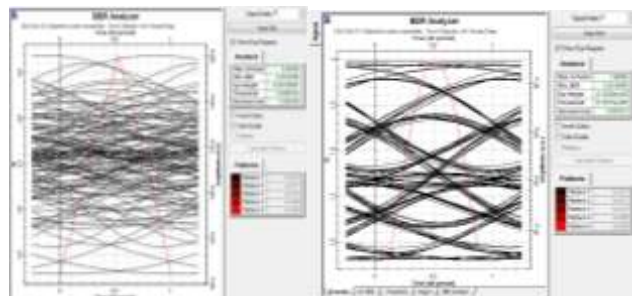

Figure. 5b

Figure 3(a-b). Comparison of transmission between FRA-FRA of sixteen and sixty four channels with wavelengths ranging from 1471 nm to 1611 nm. 3a. When FRA–FRA are connected in sixteen channel WDM system. 3b. When FRA–FRA are connected in sixty four channel WDM system.

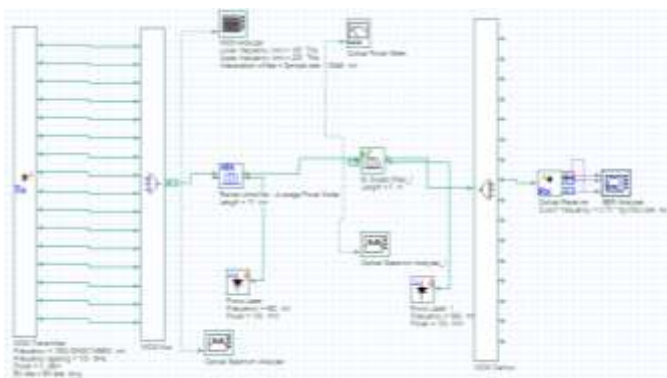

Figure. 4a

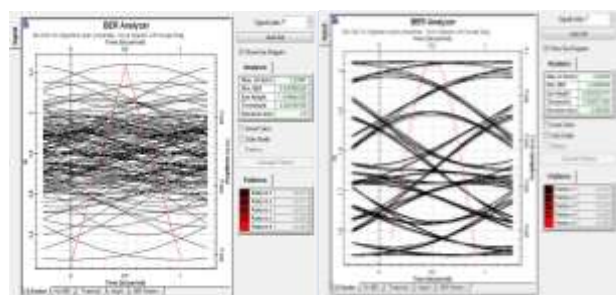

Figure. 5c

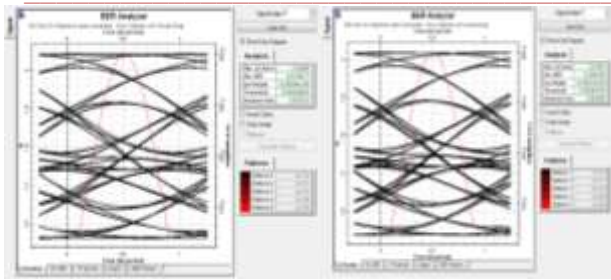

Figure. 5d

Figure 5(a-d). QUALITY FACTOR analysis between 16 and 64 channels WDM system. 5a. when EDFA-FRA are connected. 5b. when EDFA-EDFA are connected. 5c. when FRA-EDFA are connected. 5d. when FRA-FRA are connected.

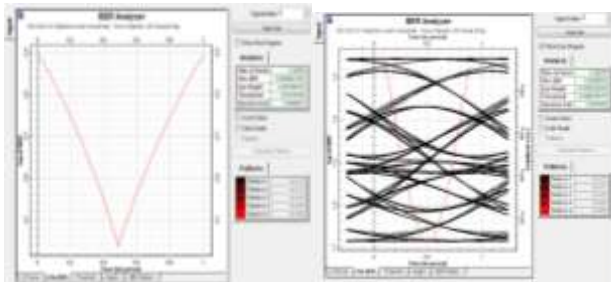

Figure. 6a

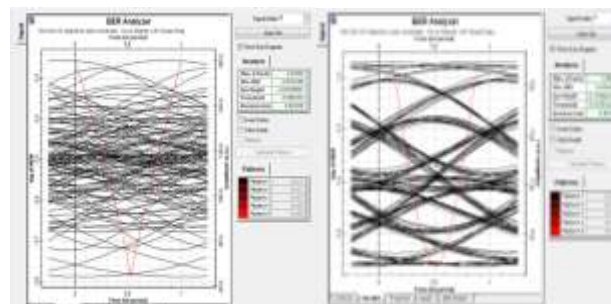

Figure. 6b

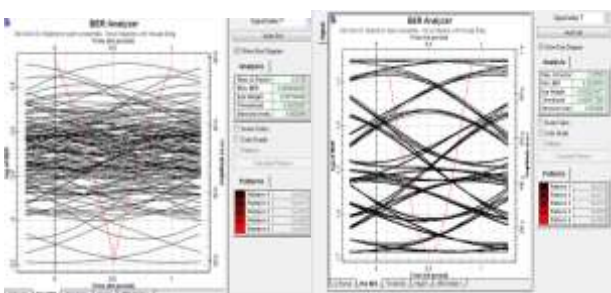

Figure. 6c

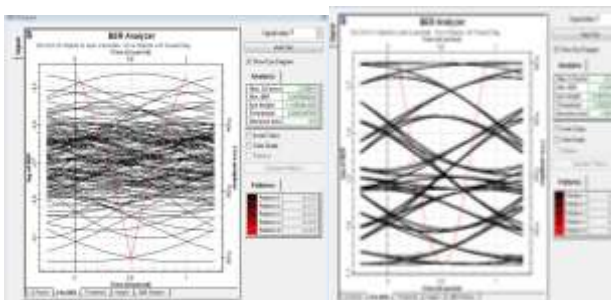

Figure. 6d

Figure 6(a-d). MINIMUM BER analysis between 16 and 64 channels WDM system. 6a. when EDFA-FRA are connected. 6b. when EDFA-EDFA are connected. 6c. when FRA-EDFA are connected. 6d. when FRA-FRA are connected.

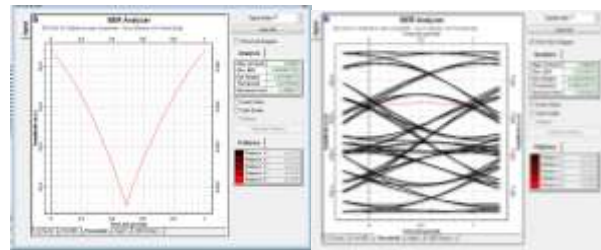

Figure. 7a

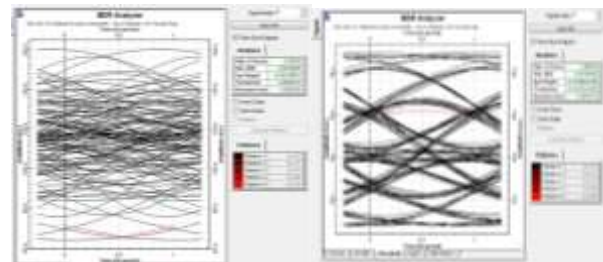

Figure. 7b

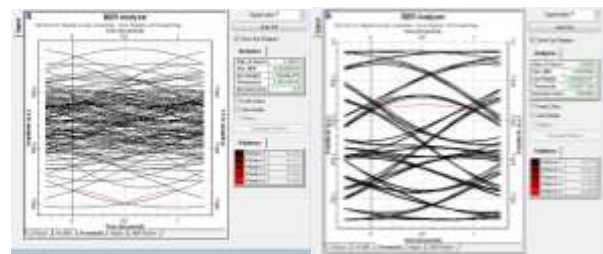

Figure. 7c

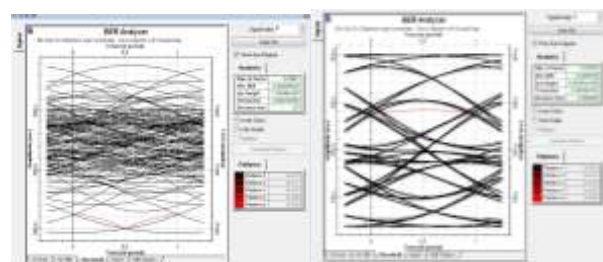

Figure. 7d

Figure 7(a-d). THRESHOLD analysis between 16 and 64 channels WDM system. 7a. when EDFA-FRA are connected. 7b. when EDFA-EDFA are connected. 7c. when FRA-EDFA are connected. 7d. when FRA-FRA are connected.

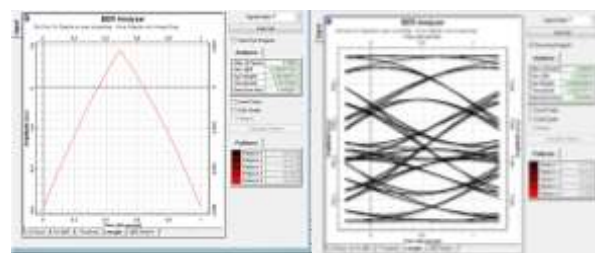

Figure. 8a

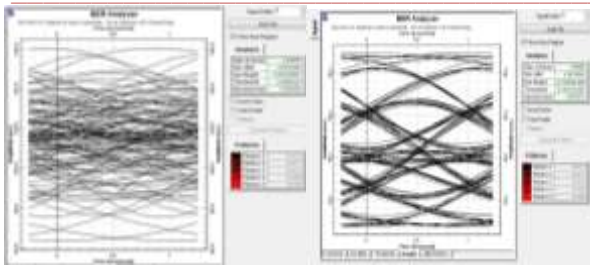

Figure. 8b

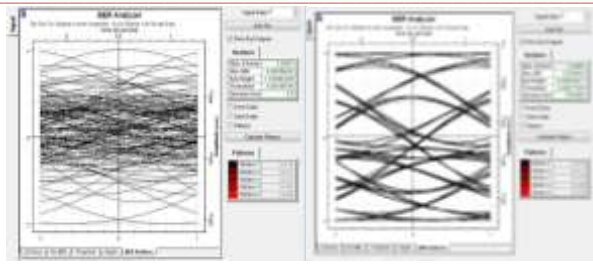

Figure. 9c

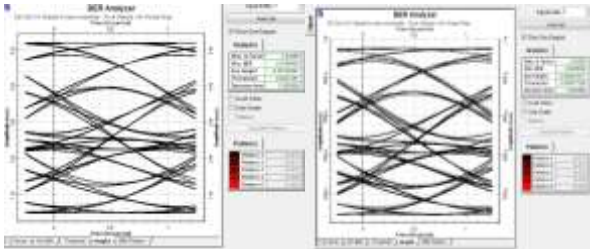

Figure. 8c



Figure. 9d

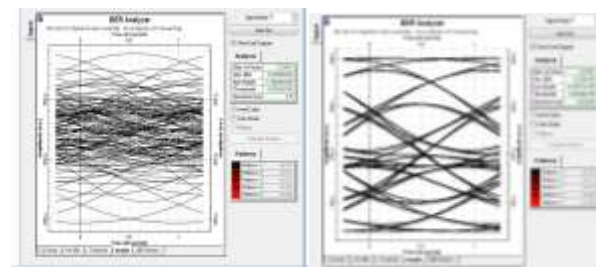

Figure. 8d

Figure 8(a-d). HEIGHT analysis between 16 and 64 channels WDM system. 8a. when EDFA-FRA are connected. 8b. when EDFA-EDFA are connected. 8c. when FRA-EDFA are connected. 8d. when FRA-FRA are connected.

Figure 9(a-d). BER PATTERN analysis between 16 and 64 channels WDM system. 9a. when EDFA-FRA are connected. 9b. when EDFA-EDFA are connected. 9c. when FRA-EDFA are connected. 9d. when FRA-FRA are connected.

II. RESULTS AND ANALYSIS-

Table for 1)16 channels.

Combination of amplifiers	FRA-EDFA	EDFA-EDFA	EDFA-FRA	FRA-FRA
MAX Q FACTOR	3.2389	3.2152	3.23991	2.93836
MIN BER	0.000591752	0.00064	0.00058226	0.0016256
THRESHOLD	0.0315198	0.0203097	0.000199798	0.0652333
HEIGHT	0.00180274	0.00104403	1.10948	-0.00105991
DECISION INSTRUMENT	0.488281	0.5039	0.5	0.523438

Table. 2)64 channels

Combination of amplifiers	FRA-EDFA	EDFA-EDFA	EDFA-FRA	FRA-FRA
MAX Q FACTOR	2.02205	1.96686	2.02528	2.01891
MIN BER	0.0206553	0.0218049	0.0205049	0.0208165
THRESHOLD	0.000676747	6.18151e-005	0.0006772889	0.000284706
HEIGHT	-0.000223926	-2.13262e-005	-0.000223477	-9.46351e-005
DEC. INS	0.501953	0.507813	0.503906	0.503906

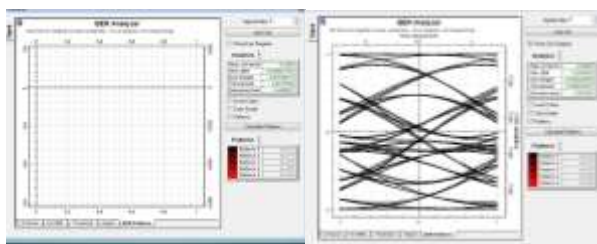

Figure. 9a



Figure. 9b

III. CONCLUSION

On the basis of analysis it has been observed that, different hybrid amplifier with combination of EDFA-FRA has better result in all the channels. Although in comparison of all channels, 16 channels has fantastic performance related to quality factor, minimum BER, height, threshold and BER pattern. Additionally, through all combinations of 16 channel and 64 channels WDM system, it is proposed that EDFA-FRA combination has the better performance.

IV. REFERENCES-

- [1] S. Chaugule and A. More, "WDM and Optical Amplifier", 2nd International Conference on Mechanical and Electronics Engineering (ICMEE 2010).
- [2] Kaur Inderpreet, Gupta Neena, "Performance Analysis of TDFA using 1050nm Pumping Power for 1479nm-1555nm Range" has been accepted and published in International Journal of Computing and Digital Systems (ISSN:2210-142X), Vol3, Issue 3, pp 227-235, 2014 (Indexed in Google Scholar, INSPEC)
- [3] A.Carena, V. Curri and P. Poggiolini, "On the Optimization of Hybrid Raman/Erbium-Doped Fiber Amplifiers", IEEE, Vol. 13, NO. 11, Nov 2001, pp 1170-1172.
- [4] Kaur Inderpreet, Gupta Neena, "Effect of ASE on Performance of EDFA for 1479nm-1555nm Wavelength Range" has been accepted and published in ITSI Transactions on Electrical and Electronics Engineering (ISSN:2320-8945) vol-2, Issue-3, pp 50-54, 2014.
- [5] Kaur Inderpreet, Gupta Neena, "Performance Evaluation of 1479nm-1555nm Band EDFA for 96 Channels DWDM System" has been accepted and published in Journal of photonics & Optoelectronics (ISSN:2304-1072) pp 70-73, 2013.
- [6] M.N. Islam, Raman Amplifiers for Telecommunications. New York: Springer, 2004, pp. 331.
- [7] I. Kaur, N., Gupta, "Comparative Analysis of Hybrid TDFA-EDFA and Hybrid EDFATDFA Configurations for 96 Channels DWDM System for S+C Bands", 2014 IEEE.
- [8] I. Kaur and N. Gupta, "Enhancing the Performance of WDM Systems by Using TFF in Hybrid Amplifiers", 2010 IEEE 2nd International Advance Computing Conference, Patiala, India, pp 106-109, Feb 2010.
- [9] I. Kaur and N. Gupta, "Hybrid Fiber Amplifiers" 1st Edition, InTech Publishers, 2012, Chapter 4, ISBN: 97-87953-51-0170-3.
- [10] I. Kaur and N. Gupta, "Optimization of Fiber Length for EDFA to Enhance the Channel Capacity of DWDM System" 2012 International Symposium on Instrumentation & Measurement, Sensor Network and Automation (IMSNA), Volume 1, pp 7 – 10, August 25-28, 2012 Sanya, Hainan.
- [11] I. Kaur and N. Gupta, "Increasing the Amplification Bandwidth of Erbium Doped Fiber Amplifiers by Using a Cascaded Raman-EDFA Configuration", Photonics 2008, P.284, Dec. 2008 at IIT, Delhi.