

Design and Implementation of High End Multiple Security Based ATM Monitoring System

B. Rajesh Rao

Asst. Professor, Dept of ECE, Jyothy Institute of Technology, Bengaluru-560082
bantwalrajeshrao@gmail.com

Priyanka Rao

Student, Dept of ECE, Jyothy Institute of Technology, Bengaluru-560082
writetopriyanka.rao@gmail.com

Rachana G N

Student, Dept of ECE, Jyothy Institute of Technology, Bengaluru-560082
rachanagn15@gmail.com

Sushma B V

Student, Dept of ECE, Jyothy Institute of Technology, Bengaluru-560082
sushmakaundinya@gmail.com

Abstract: Design and Implementation of High End Security based ATM Monitoring System is invented as a result of observations made in our real life incidents happening around us. This Implementation deals with prevention of ATM robbery with added high end algorithm to the existing technology found in our society. Whenever ATM theft attempt occurs, vibration produced from the machine will be sensed by attached sensor module to it. A panic switch is another module for additional security. Once Vibration is sensed or panic switch activated, a high alert message will be sent to the nearest police station and Bank Authorities using GSM module and a buzzer beep sound will occur at the same time. This system uses PIC controller based embedded system to process real time data collected using sensor and panic switch module. In addition it also restricts the number of occupiers of the machine to single within the pre defined area. This is achieved by processing 3 dimensional real time IR sensors data using ONE_AT_TIME algorithm.

Keywords: Multiple Security, ATM, Vibration sensor, panic switch, GSM module, PIC controller

I. INTRODUCTION

Wherever there is wealth there should be enough security in today's world. Though ATMs are a convenience to common people, it's also a high threat. In today's technically advanced world, autonomous systems are gaining rapid popularity. As the social computerization and automation has been increased and the ATM and credit card has been installed and spread out to simplify the activity for financial activity, the banking activity has been simplified, however the crime related with financial organization has been increased in proportion to the ratio of spread out of automation and devices [1]. To avoid these threats such as looting, murders, we need to provide adequate securities. Our project describes a method to provide necessary security and aid to the people by using Embedded Technology.

II. EXISTING SYSTEM

In this system we have a watchman and a camera to monitor the ATM system. The recent enhancement made in the security system for a few ATMs is that it is provided with security to the entrance doors itself such that to enter the ATM we need to use the card to unlock the door. System for a few ATMs is that it is provided with security to the entrance doors itself such that to enter the ATM we need to use the card to unlock the door.

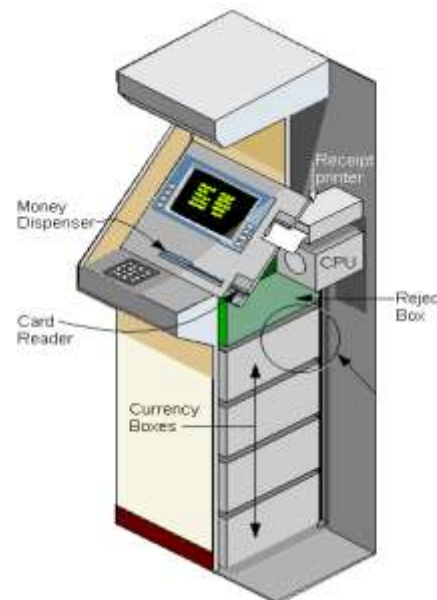

Figure 1 – Existing System

III. PROPOSED SYSTEM

In this system, we have vibration sensors mounted inside the ATM machine. Whenever the vibration sensors get active, then the shutters of the ATM will fall automatically and send a message to the nearest police station. A panic switch is integrated outside the ATM machine to avoid panic situations at the ATM.

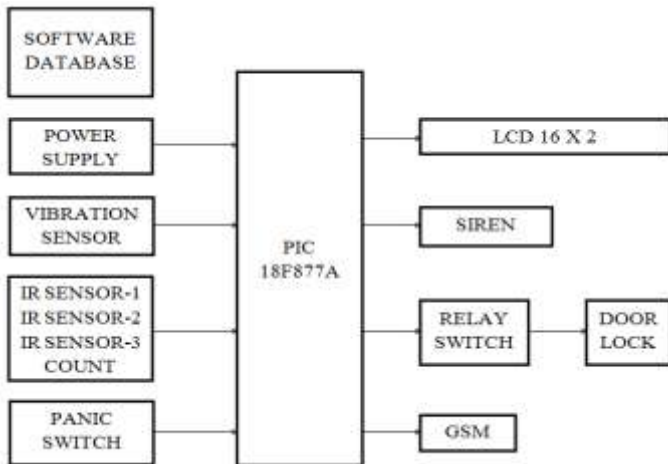

Figure 2-Block Diagram of proposed system

The vibration sensor is mounted inside the ATM machine. In case there is any movement or disturbance more than the threshold vibration (3.3v), then it triggers an output high or low which will alert the Micro-Controller which keeps checking the particular pin. Once the interrupt is occurred, the shutters of the ATM get locked automatically. The microcontroller is connected to the GSM which sends a SMS to the nearest police station or the banker through serial communication. The GSM connected over here should have a working SIM. The emergency numbers are stored in the code of the chip. IR sensors are used to keep the count the number of people entering within the white line. A panic switch is mounted outside the ATM machine for panic situations such as threatening, manhandling and cosy situation. If the panic switch is toggled, then the buzzer gets activated and a message will be sent to the authorized number. The LCD is used to display all the events which take place in the microcontroller.

IV. PIC Microcontroller

The micro controller used in our project is 16f877A. It is the heart of our project. The PIC microcontroller is an 8 bit controller with 20MHz frequency and 5 volt power supply. It consists of 5 input/output bidirectional ports. The controller is interfaced with an 8 bit LCD, GSM SIM 900, vibration sensor, infrared sensor, panic switch and a DC

geared motor.

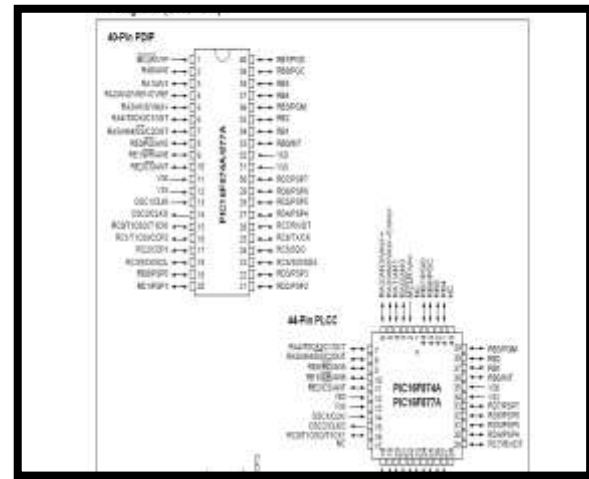

Figure 3 – Pin Diagram of PIC Microcontroller

Power supply

The main structure of any electronic system is the power supply to provide required power for their setup. For the microcontroller, LCD, GSM, IR sensor, Vibration sensor, Relay switch and the buzzer, +5V are required. The power supply provides regulated output of +5V.

V. GSM

A GSM modem is a specialized type of modem which accepts a SIM card, and operates over a subscription to a mobile operator, just like a mobile phone. While these GSM modems are most frequently used to provide mobile internet connectivity, many of them can also be used for sending and receiving SMS and MMS messages. GSM is one of the representative wireless networks which have low-power, low-cost and convenience to use.

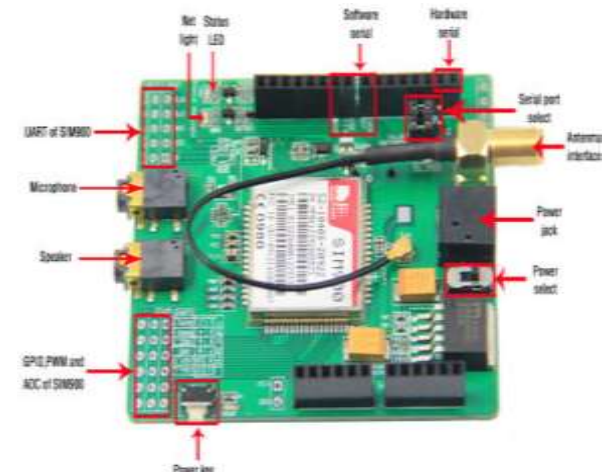

Figure 4 – GSM Module SIM 900A

A GSM modem can be a dedicated modem device with a serial, USB or Bluetooth connection, or it can be a mobile

phone that provides GSM modem capabilities. Most GSM networks operate in the 900 MHz or 1800 MHz bands.

In our project the major function of GSM is to send a SMS to the nearest police station through serial communication. The GSM connected over here should have a working SIM. The emergency numbers are stored in the code of the chip.

VI. Vibration Sensor

This sensor safeguards a piezoelectric transducer. As the transducer is exiled from the mechanical neutral axis, bending creates strain within the piezoelectric element and generates voltages. If the assembly is supported by its escalating points and left to vibrate “in free space” the device will act as a form of vibration sensor.



Figure 5 – Vibration Sensor

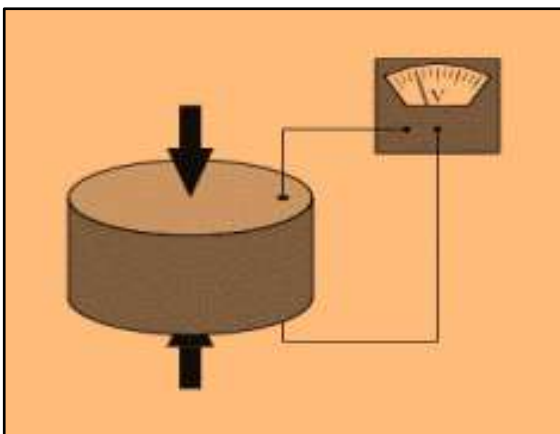

Figure 6 – Piezoelectric Transducer

The sensing element should not be treated as a flexible switch, and is not intended to be bent. The vibration sensor is mounted inside the ATM machine. In case there is any movement or disturbance more than the threshold vibration, then it triggers an output high or low which will alert the Micro-Controller that keeps checking the particular pin.

VII. Infrared Sensor

This Medium Range Infrared sensor offers simple, user friendly and fast obstacle detection using infrared; it is noncontact detection. The Medium Range Infrared Sensor has a sensing range of approximately 2cm to 8cm. We use IR sensors to count the number of entries in the ATM.

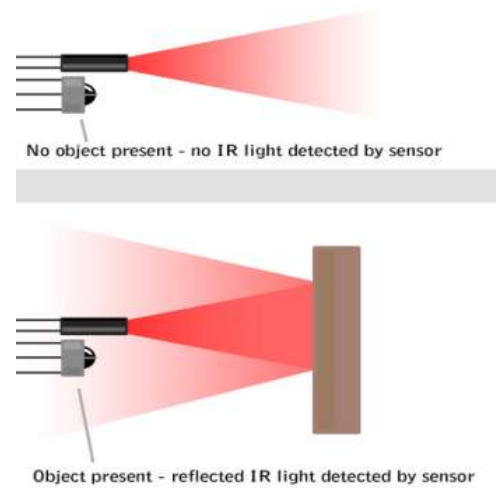

Figure 7 – Light detected by IR Sensor

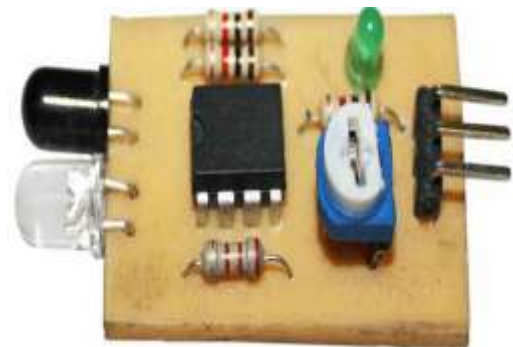

Figure 8 – IR Sensor

Pin	Name	Function
+	Vcc	Supply +4 to +6V
-	Ground	Connects to ground
s	Output Signal	Connects to I/O pin of microcontroller which is set to input mode

Table 1 – Pin Definitions and Rating

Parameter	Min	Max	Unit
Operating Voltage	4	6	V
Sensing Range	2	8	cm

Table 2 – Maximum Range

VIII. LCD

LCD is a thin, flat panel used for electronically displaying information such as text, images, and moving pictures. Its uses include monitors for computers, televisions, instrument panels, and other devices ranging from aircraft cockpit displays, to every-day consumer devices such as video players, gaming devices, clocks, watches, calculators, and telephones. Among its major features are its lightweight construction, its portability, and its ability to be produced in much larger screen sizes than are practical for the construction of cathode ray tube (CRT) display technology. Its low electrical power consumption enables it to be used in battery-powered electronic equipment. This is used to display the situation which is happening in the microcontroller and creates a visual interface for the user.

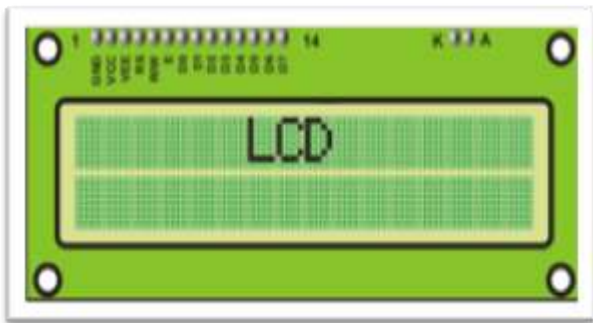

Figure 9 - LCD

IX. RESULT

The overall system was designed and tested under controlled environments, vibration sensor and panic switch are continuously detected and the message is been delivered to the nearest police station. IR sensor continuously monitors the number of people entering the ATM vault.



Figure 10 – System Overview

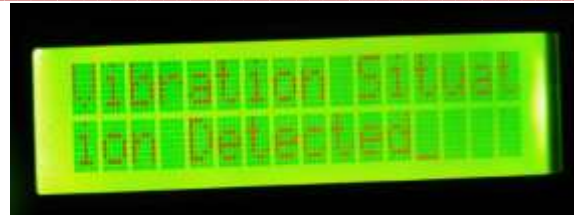

Figure 11 – Proposed Result

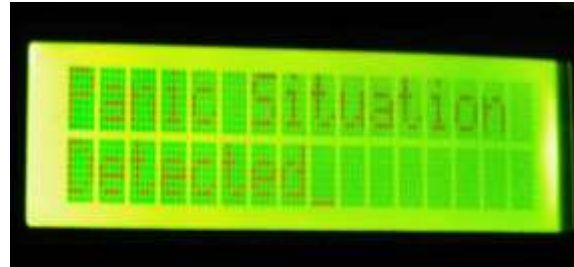

Figure 12 – System Result

CONCLUSION

These days most of the ATM is prone robberies. Also there is a steady increase in the theft of ATM year after year. This paper validates how a mechanization of “ATM THEFT” helps in prevention from robbery (or) theft and can be eluded by using GSM Technology, vibration sensor, dc motor, LCD display, and panic switch. By implementing this project we can catch thieves in ATM itself and also we can save our precious time.

REFERENCES

- [1] “Design and Implementation of Security Based ATM theft monitoring system”, Sivakumar T.1, Gajjala Askok2, k. Sai Venuprathap3 1M. Tech (Embedded systems), Dept. of ECE, Kuppam Engineering College, Kuppam, Chittoor (dst), A.P, India 2M. Tech (Embedded systems), Dept. of ECE, KEC, Kuppam -AP 3Dept. of ECE, Asst. Professor, Kuppam Engineering College, Kuppam, Chittoor (dst), A.P, India. International Journal of Engineering Inventions e-ISSN: 2278-7461, p-ISSN: 2319-6491 Volume 3, Issue 1 (August 2013) PP: 01-07
- [2] “Advanced Security Model for Detecting Frauds in ATM Transaction”, Vivek . V. Jog, Assistant Professor Dept. of Comp. Engg. SKNCOE, Pune .Nilesh R. Pardeshi PG Student University of Pune SKNCOE, Pune. International Journal of Computer Applications (0975 – 8887) Volume 95– No. 15, June 2014
- [3] “Anti-Theft ATM Machine Using Vibration Detection Sensor”, M. Ajaykumar* N. Bharath Kumar, M.Tech (S.E.) & SNIST, Hyderabad B.Tech-CSE Department & JNTU, Hyderabad India. Volume 3, Issue 12, December 2013 ISSN: 2277 128X, International Journal of Advanced Research in Computer Science and Software Engineering Research Paper. Available online at: www.ijarcsse.com.

Authors

Mr. B. RajeshRao is associated with Jyothy Institute of Technology, Bengaluru as an Assistant Professor in the Department of Electronics and Communication Engineering.

Ms. Priyanka. Rao is pursuing BE in Electronics and Communication at Jyothy Institute of Technology, Bengaluru, Karnataka, India.

Ms. Rachana.G.N is pursuing BE in Electronics and Communication at Jyothy Institute of Technology, Bengaluru, Karnataka, India.

Ms. Sushma.B.V is pursuing BE in Electronics and Communication at Jyothy Institute of Technology, Bengaluru, Karnataka, India.